



## Installation Instructions

[Echelon, Traditions & Integra Aluminum Blinds](#)

[2" Metro Aluminum Blinds](#)



## Echelon™, Traditions™ & Integra™ Aluminum Blinds

Thank you for choosing Lafayette aluminum blinds. With proper installation and care, your new aluminum blinds will provide many years of beauty and performance.

### Tools and Fasteners Needed

Power Drill, 1/4" Driver and drill bits  
Tape Measure  
Flat blade Screwdriver  
Phillips Screwdriver  
Pencil  
Level



Mounting Surface	Fastener
Wood	#6 Hex Head Provided 
Drywall, Plaster	Wall Anchors Not Provided 
Metal	Sheet Metal Not Provided 

### Before Installing

Remove shade from the package. Keep all packaging until the shade operates to your satisfaction.

- Contents of your hardware package may vary depending on options chosen.
- Blinds over 60 sq. feet will be sent with one extra support bracket (Traditions) or one extra installation bracket (Integra) to be spaced evenly along the headrail at a maximum distance between brackets of 60".
- Additional fasteners may be needed based on your specific mounting surface.

Blind Width	Supports Required
Up to 60 1/16"	0
60 1/4" - 120 1/16"	1
Over 120 1/4"	2

### Traditions Headrail: Mounting Inside or Outside

- For inside installations, mount the brackets in the corner of the jambs.
- For outside installations, hold the blind level at the desired height and mark the window frame on the end and bottom of the headrail. The brackets should be located 1/4" beyond the end of the headrail marks.
- The brackets must be level in order for the blind to operate properly.

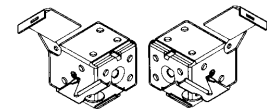

Traditions Installation Brackets

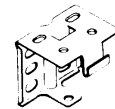

Traditions Support Bracket

### Traditions Headrail: Bracket Attachment

Two hinged-cover installation brackets (marked "L" for the left side and "R" for the right side) are provided for each blind. The safety lock cover will secure the blind firmly into place.

- Open the bracket cover by inserting a screw driver into the rectangular slot and twisting.
- Each bracket is designed to be mounted with two diagonally located screws.

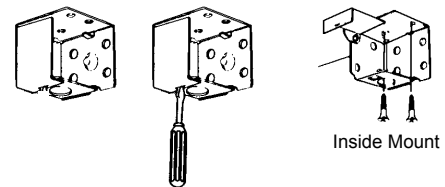

Inside Mount

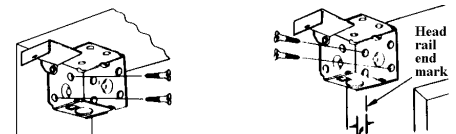

Inside Mount

Outside Mount

### Supporting Wide Blinds

If the blind is over 60" wide (and/or 60 square feet in area) an intermediate support is required. It should be close to the center, but must not interfere with the headrail components. For blinds over 120" wide, two support brackets must be installed. Use a level to align the support brackets with the end brackets.

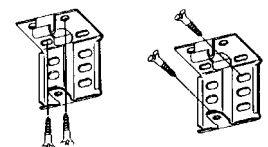
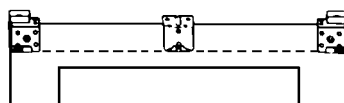

Inside Mount

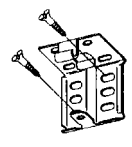

Outside Mount

### Traditions Headrail: Installing the Headrail

Check the headrail to be sure nothing is tangled. Be sure to keep the top slat from sliding into the brackets. On inside mounts if a valance is being used, see instructions below before installing the headrail.

- If support brackets are used, slip the headrail into the lip of the bracket and push into place.
- If supports are not used, slip the headrail into the brackets and snap safety locking cover shut.
- If the blind is loose in the brackets, open the end brackets and expand the end lock tab(s) on the headrail by using a screw driver.
- If the blind is too tight, compress the tab by pushing it in on one or both sides.

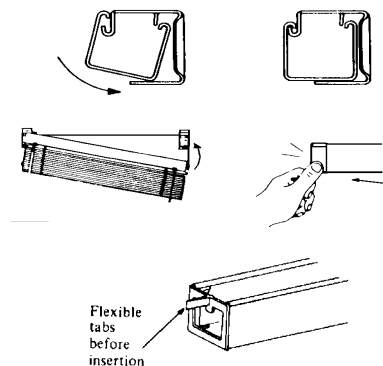

### Traditions Headrail: Installing the Valance

The Regal valance is available by request for Traditions 820, Traditions Light-Ban and Traditions Micro blind. A Two slat clip-on valance is available by request for Traditions 822, Traditions 620 and Traditions 622 blind.

- Install the valance with the clips provided. For inside mount blinds, attach the valance clips to the headrail before installing the blind.
- If a return is needed, the valance can be bent to form a return.
- Tilt the Regal valance will rest on the bottom groove and snap onto the top two grooves.
- Slide the slats for the Two slat valance into the grooves on the valance clips.

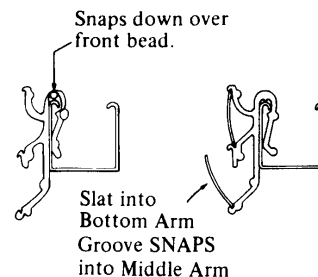

### Echelon & Integra Headrails: Mounting Inside or Outside

Position the two end brackets on the mounting surface so that they will be located between 2" and 6" from the ends of the headrail. If more brackets are required, space additional brackets evenly between the end brackets. Do not position any bracket directly above a ladder, cordlock or wand tilter. Allow 1" space on the side whenever possible.

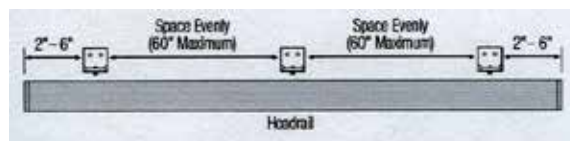

### Echelon & Integra Headrails: Securing the Brackets

#### Inside Mount Bracket Attachment

A minimum casement depth of 7/8" is required for inside mount. A depth of 1 3/4" is required to fully recess the blind.

- Attach the installation brackets with two screws through the two holes in the top of the brackets.
- Be sure the front edges of the brackets are aligned before tightening the screws.

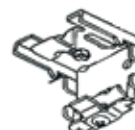

#### Outside Mount Bracket Attachment

A flat surface of at least 5/8" high is required for bracket attachment.

- Attach the installation brackets with two screws through the two holes in the rear of the brackets.
- Use a level to check that the tops of the brackets are aligned at the same height before tightening the screws.

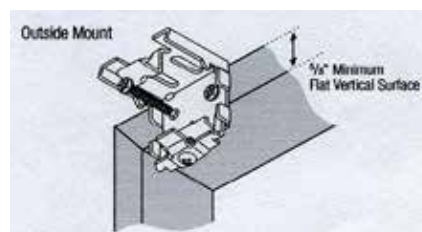

### Echelon & Integra Headrails: Installing the Headrail

Be sure the bracket tab is fully extended to the head of the screw.

- Place the headrail in the brackets so that the front lip rests on the bracket hook and the rear bottom corner rests on the tab.
- The blind should hang on the brackets without being held in place.
- Tilt the headrail up and push it back until it is flush against the top of the installation brackets. Tighten the locking screw on all brackets to hold the blind securely in place.
- To remove the headrail, reverse installation procedure. Loosen the locking screw, tilt the headrail, and lift off the bracket hook.

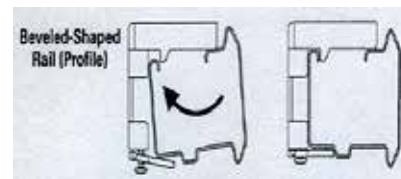

## Optional Hold-Down Brackets

### Plastic Hold-Down Brackets

- Attach the hold-down brackets to the jamb, sill or outside mounting surface. When the blind is fully lowered, the pin on the hold-down must align with the center of the bottom rail end cap.
- Insert the pin on the hold-down brackets into the end caps to secure the bottom rail. A hole may need to be punched in the end cap to accept the pin in the hold-down.

### Metal Hold-Down Brackets

- Insert a hold-down pin into each of the bottom rail end caps.
- Attach the hold-down bracket to the jamb, sill or outside mounting surface. When the blind is fully lowered, the hold in the hold-down brackets must align with the pins in the bottom rail end cap.
- Insert the pins into the holes in the hold down brackets.

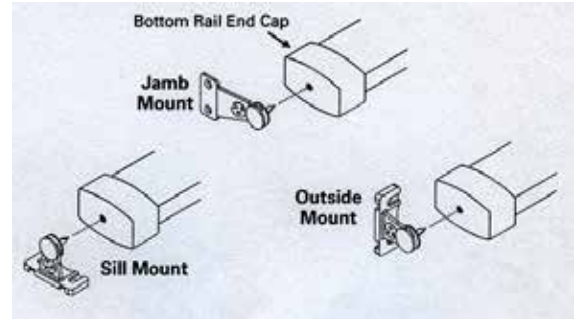

## Optional Extension Brackets

Extension brackets can be used on outside mounts to project the installation brackets from 2 3/4" to 4 1/8" from the mounting surface. This allows additional clearance of obstructions such as window cranks or handles.

- The extension brackets may be fastened together two different ways to produce the desired wall extension as shown.
- Attach the extension brackets using the nut and bolts sent.
- Mount the extension bracket assemblies to the window frame or wall using two diagonally located screws.
- Use the appropriate fasteners to bolt the mounting brackets to the extension brackets.

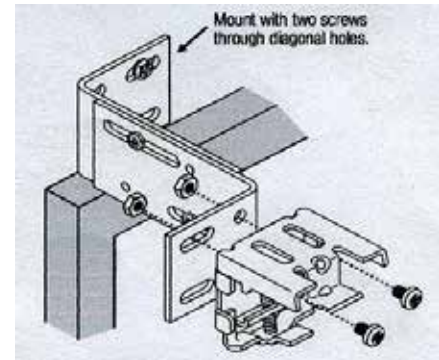
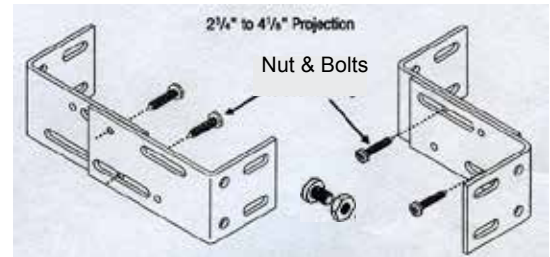

## Wand Tilter

.006 gauge blind wands are provided with a clip on wand tilter that simply "snaps" onto the wand tilter.

- Grasp wand tip between forefinger and thumb.
- Rotate the tilter until the hole is horizontal with the slats and push wand into hole on the tilter as shown.

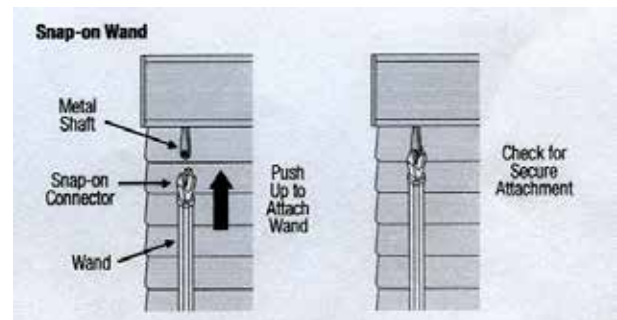

.008 gauge blind wands are provided with a plastic sleeve and metal hook.

- Remove the plastic sleeve by pulling upward. The hook on the wand will be in an open position.
- Slide the plastic sleeve removed from the wand over the metal shaft of the tilter until the hole is exposed.
- Holding the sleeve above the hole, pull the wand hook through the shaft hole until it rests in the bend of the hook.
- Slide the plastic sleeve back down over the hook until it is back in the closed position.

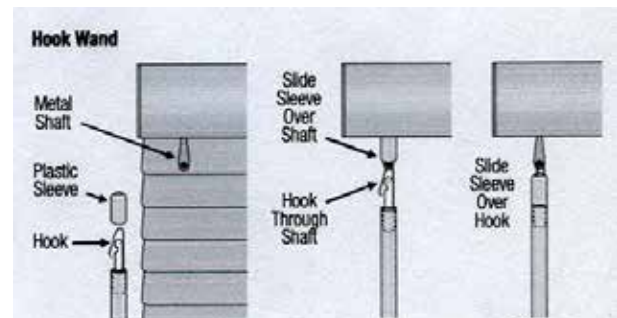



## Raising and Lowering Blinds

The slats must be in the horizontal (open) position before raising or lowering. An automatic locking device takes effect when the cords hang down vertically.

- Pull the cords toward the middle and down slightly to open the lock.
- When the blind is at the desired height, pull the cords to the outside to lock in position.

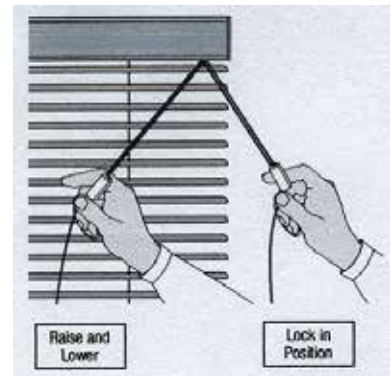

## Cord Stop

- This component acts as a stopper to prevent inner cords from being pulled through the blind, which can pose a risk of entanglement.
- It is also designed to break apart under significant pressure, which may lessen the risk of entanglement in the top lift cords.

## Reassembly of Cord Stop

- Reinsert any loose cords into the top notches of the cord stop. There is a notch on each side.
- Line up the two halves of the cord stop and snap the pieces back together.

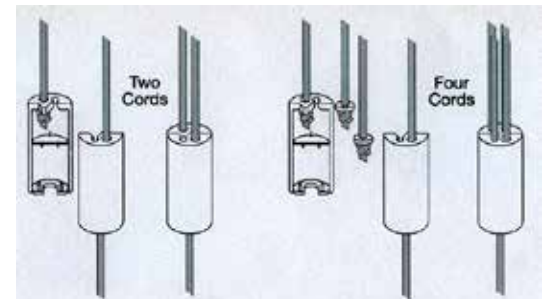

## Child Safety

Young children can STRANGLE in cord loops and in the loop above the cord stop. They can also wrap the cord around their necks and STRANGLE. In addition, inner cords can pull out to form a loop, which can STRANGLE a child.

- Always keep cords out of children's reach.
- Move cribs, playpens and other furniture away from cords. Children can climb furniture to get to cords.
- Do not tie cords together. Make sure cords do not twist together to create a loop.

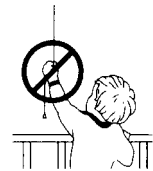

## Care and Cleaning

- Dust with a soft, clean cloth or chemically treated dust cloth. Tilt the slats up and dust. Then tilt the slats down (but not all the way closed) and dust the other side of the slats.
- Vacuum using the brush attachment or hand held vacuum and tilt the slats up and down as described.
- Wash slats using a damp cloth and mild detergent. Use warm or cold water, not hot water. Tilt the slats up and down as described.
- Bottom rail and slats may also be immersed in a bathtub for a more thorough cleaning. Do not immerse the headrail. Place the blind in a solution of mild, soapy water. Rinse clean and either wipe dry or allow to air dry completely.



[www.lafayetteinteriorfashions.com](http://www.lafayetteinteriorfashions.com)

18-3537-01 April 2014



## 2" Metro™ Aluminum Blinds

Thank you for choosing Lafayette aluminum blinds. With proper installation and care, your new aluminum blinds will provide many years of beauty and performance.

### Tools and Fasteners Needed

Power Drill, 1/4" Driver and drill bits  
Tape Measure  
Flat blade Screwdriver  
Phillips Screwdriver  
Pencil  
Level

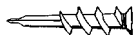

Mounting Surface	Fastener
Wood	#6 Hex Head Provided 
Drywall, Plaster	Wall Anchors Not Provided 
Metal	Sheet Metal Not Provided 

### Before Installing

Remove shade from the package. Keep all packaging until the shade operates to your satisfaction.

- Contents of your hardware package may vary depending on options chosen.
- Additional fasteners may be needed based on your specific mounting surface.

Blind Width	Supports Required
Up to 72"	0
72 1/16" - 96"	1
96 1/16" - 144"	2

### Inside and Ceiling Mount

Attach the two end brackets flush against the sides of the window casement or ceiling. Choose the most appropriate of the following mounting methods:

- Open end mount bracket as shown. A screw driver may be inserted into the rectangular slot and twisting.
- Side mount brackets with one screw through a side hole and one screw through a top holes.
- If the brackets are flush with the back wall, attach them with one screw through a top hole and one through a rear hole.
- Top mount the brackets with screws through the top holes.
- If limited mounting depth is available, the bracket may be mounted with two screws through diagonal side holes.

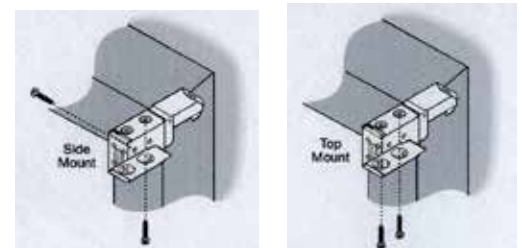
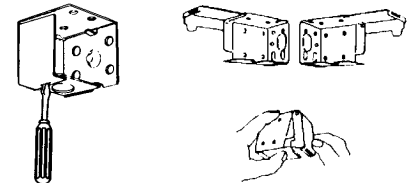

### Intermediate Brackets

Evenly space the intermediate bracket or brackets between the two end brackets. A minimum depth of 1 1/8" is required for bracket attachment.

- Adjust spacing if needed to avoid interference with the internal head-rail mechanisms.
- Attach with two screws through diagonal holes.
- The backs of the end brackets and intermediate brackets should line up with each other.
- With ceiling mounts, you may need to add a bracket shim to allow clearance for the valance clip.



### Bracket Shims (Optional)

Bracket shims may be used whenever the mounting surface is not flat enough to mount the blind correctly.

### Install Valance Clips

- Attach valance clips to the headrail as shown.
- Evenly space valance clips along the length of the headrail. DO not place a valance clip where it can interfere with working parts.

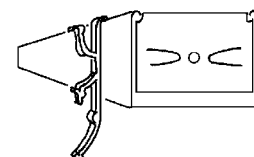

## Outside Mount

A flat surface of at least 1 3/4" high is required for bracket attachment

- Mark where the ends of the headrail will be located.
- Either hold the headrail up to the mounting surface or measure the headrail and mark its length.
- Then mark 1/4" to the outside of the headrail marks.

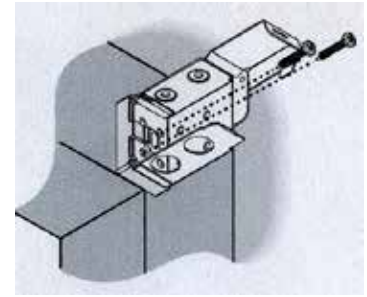

## Attach End Brackets

- Align the outside edge of each bracket with the outer marks.
- The tops of the brackets must be aligned at the same height.
- Attach the brackets with two screws through diagonal holes.

## Intermediate Brackets

Evenly space the intermediate bracket or brackets between the two end brackets.

- Adjust spacing if needed to avoid interference with the internal headrail mechanisms.
- The top of each intermediate bracket must be aligned with the tops of the end brackets.
- Attach bracket(s) with two screws through diagonal holes.

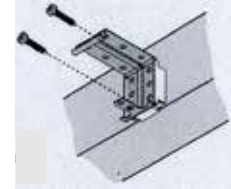

## Optional Extension Brackets

Extension brackets can be used on outside mounts to project the installation brackets from the mounting surface. This allows additional clearance of obstructions such as window cranks or handles.

- Align and level extension brackets with a carpenter's level.
- Attach the extension brackets using the nut and bolts sent.
- Mount the extension bracket(s) to the window frame or wall using two diagonally located screws.
- Use the appropriate fasteners to bolt the mounting brackets to the extension brackets.

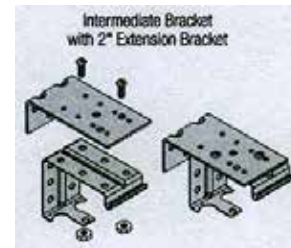
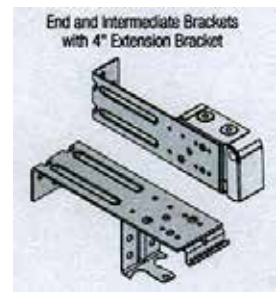
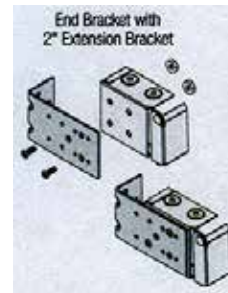

## Mount the Headrail

- Tilt the headrail so that its back lip slides under the front lip of the end brackets and intermediate bracket(s).
- Push the headrail against the back of the end brackets.
- Check that the front lip of the intermediate bracket(s) is under the front lip of the headrail.

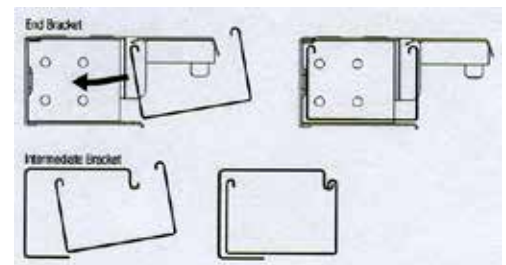

## Adjust Headrail Tightness

- If the headrail is loose in the end brackets, bend the tabs on the end plates outward.
- The tabs may be bent inward if the headrail was difficult to install into the end brackets.

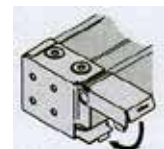
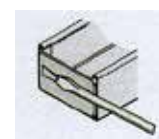

## Close End Brackets

- Push the cover down until it snaps over the locking tab on the bottom of the bracket.

### Install Slat Valance

- Slat valances use a clear clip for installation.
- Tilt the slat to insert the bottom into the bottom notch of the clip.
- Snap the top of the slat into the top notch of the clip.

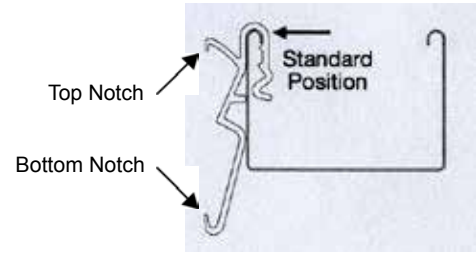

### Install Monarch Valance

- Monarch valances use a clear clip for installation.
- Tilt the valance to insert the bottom into the bottom notch of the clip.
- Snap the top of the valance into the top notch of the clip.

### Install Camelot or Majesty Valances

Camelot and Majesty will come with a quick clip attached to the back of the valance.

- Tilt the top of the valance onto the top notch of the clip.
- Push down on the valance to snap into the middle notch of the valance clip.

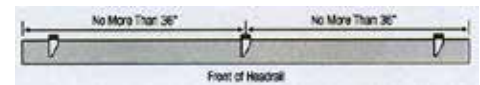
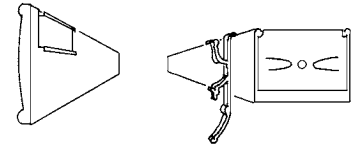

### Camelot or Majesty Valances with Dust Cover

If a dust cover is requested, a cornice clip will be sent for attachment.

- Attach a clip 2" from each end of the headrail.
- Space additional clips evenly between the two end clips so that the clips are no more than 36" apart.
- To attach the cornice clips, hook the back of the clip to the rear lip of the headrail.
- Push the clip down until it snaps firmly into place.
- If mounting to a door, secure the dust cover to the clip with a 1/4" wood screw (not provided).

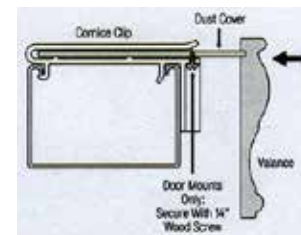
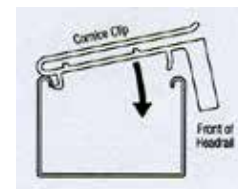

### Optional Hold-Down Brackets

#### Plastic Hold-Down Brackets

- Attach the hold-down brackets to the jamb, sill or outside mounting surface. When the blind is fully lowered, the pin on the hold-down must align with the center of the bottom rail end caps.
- Insert the pin on the hold-down brackets into the end caps to secure the bottom rail. A hole may need to be punched in the end cap to accept the pin in the hold-down.



### Wand Tilter

- Remove the plastic sleeve by pulling upward. The hook on the wand will be in an open position.
- Slide the plastic sleeve removed from the wand over the metal shaft of the tilter until the hole is exposed.
- Holding the sleeve above the hole, pull the wand hook through the shaft hole until it rests in the bend of the hook.
- Slide the plastic sleeve back down over the hook until it is back in the closed position.

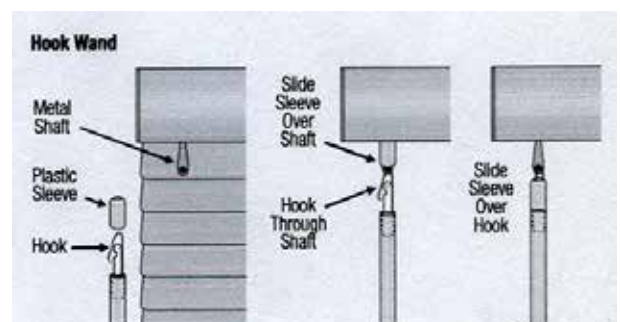



## Raising and Lowering Blinds

The slats must be in the horizontal (open) position before raising or lowering. An automatic locking device takes effect when the cords hang down vertically.

- Pull the cords toward the middle and down slightly to open the lock.
- When the blind is at the desired height, pull the cords to the outside to lock in position.

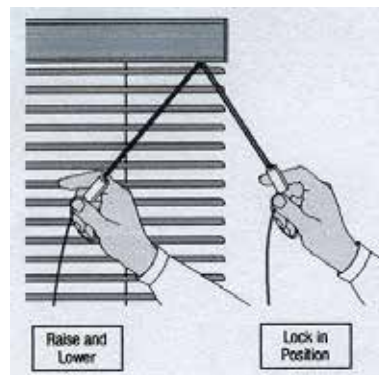

## Cord Stop

- This component acts as a stopper to prevent inner cords from being pulled through the blind, which can pose a risk of entanglement.
- It is also designed to break apart under significant pressure, which may lessen the risk of entanglement in the top lift cords.

## Reassembly of Cord Stop

- Reinsert any loose cords into the top notches of the cord stop. There is a notch on each side.
- Line up the two halves of the cord stop and snap the pieces back together.

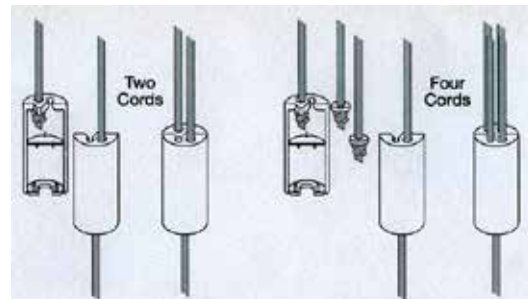

## Child Safety

Young children can STRANGLE in cord loops and in the loop above the cord stop. They can also wrap the cord around their necks and STRANGLE. In addition, inner cords can pull out to form a loop, which can STRANGLE a child.

- Always keep cords out of children's reach.
- Move cribs, playpens and other furniture away from cords. Children can climb furniture to get to cords.
- Do not tie cords together. Make sure cords do not twist together to create a loop.



## Care and Cleaning

- Dust with a soft, clean cloth or chemically treated dust cloth. Tilt the slats up and dust. Then tilt the slats down (but not all the way closed) and dust the other side of the slats.
- Vacuum using the brush attachment or hand held vacuum and tilt the slats up and down as described.
- Wash slats using a damp cloth and mild detergent. Use warm or cold water, not hot water. Tilt the slats up and down as described.
- Bottom rail and slats may also be immersed in a bathtub for a more thorough cleaning. Do not immerse the headrail. Place the blind in a solution of mild, soapy water. Rinse clean and either wipe dry or allow to air dry completely.

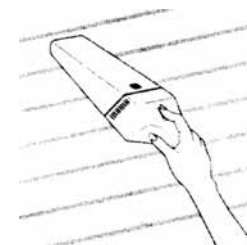

www.lafayetteinteriorfashions.com  
51-09-620 April 2014